

# TROMBONE POSITION CHART

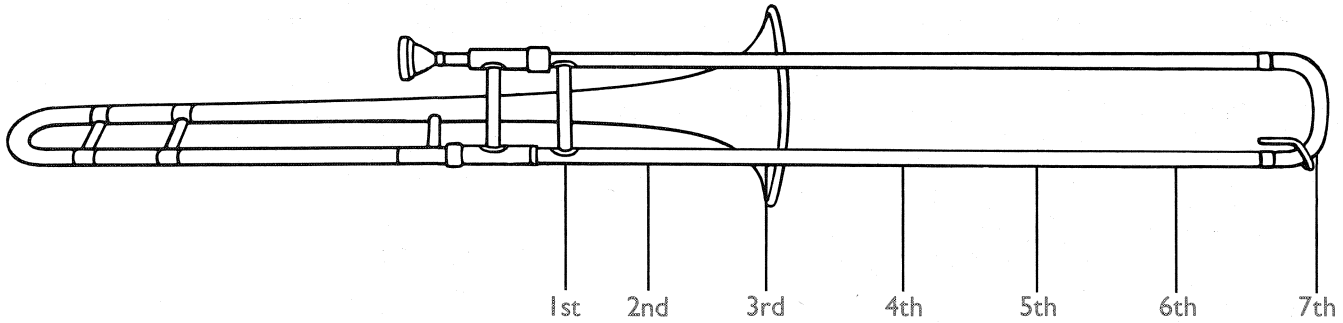

## SLIDE POSITIONS

Numbers under notes indicate slide positions.

E F F# G<sup>b</sup> G G# A<sup>b</sup> A A# B<sup>b</sup> B

7 6 5 4 3 2 1 7

C C# D<sup>b</sup> D D# E<sup>b</sup> E F F# G<sup>b</sup>

6 5 4 3 2 1 OR 6 5







G G# A<sup>b</sup> A A# B<sup>b</sup> B C C# D<sup>b</sup> D

4 3 2 1 OR #5 4 3 2 1 OR b4

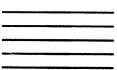
D# E<sup>b</sup> E F F# G<sup>b</sup> G G# A<sup>b</sup> A A# B<sup>b</sup>

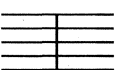
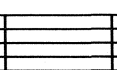
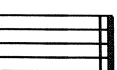
3 2 1 #3 #2 #3 2 1

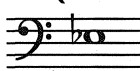
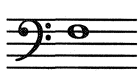

<p><b>STAFF</b></p> 	<p><b>BASS CLEF</b></p> 	<p><b>BAR LINE</b></p> 	<p><b>MEASURE</b></p> 	<p><b>DOUBLE BAR</b></p> 
<p><b>WHOLE NOTE</b></p>  <p>4 beats</p>	<p><b>WHOLE REST</b></p>  <p>4 beats of silence</p>	<p><b>TIME SIGNATURE</b></p> <p><math>\frac{4}{4}</math> = 4 beats to a measure  <math>\frac{4}{4}</math> = quarter note  gets 1 beat</p>		
<p><b>D</b></p>  <p>4</p>	<p><b>E<math>\flat</math> (E flat)</b></p>  <p>3</p>	<p><b>F</b></p>  <p>1</p>		

**1** **D**

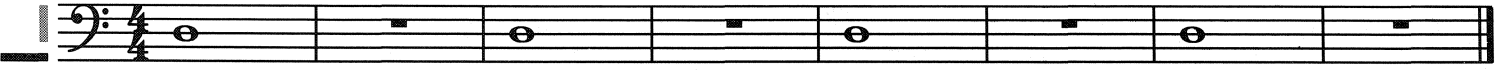

1 2 3 4   1 2 3 4   1 2 3 4   1 2 3 4   1 2 3 4   1 2 3 4   1 2 3 4   1 2 3 4

**2** **E $\flat$**



**3** **F**

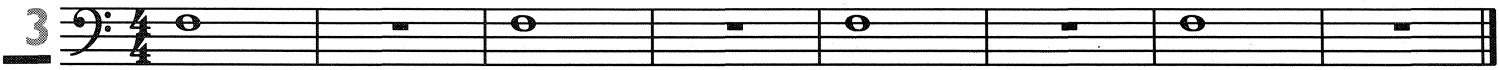

**4**

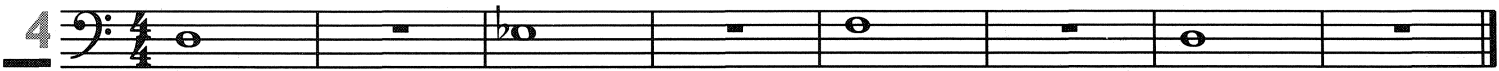

**5**

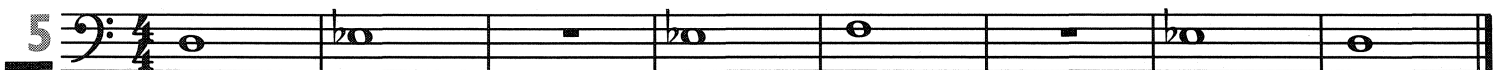

**6**

